



The Power to Surprise

SPORTAGE

Nothing Like It

When elegance meets practicality and together they drive into the realm of comfort and class, Sportage stands in the doorway to welcome them with open arms. Meet Sportage, your very own Urban SUV that combines high comfort and spaciousness, with class and innovativeness – all in one revolutionary design, unlike any other.





Elegance On The Move

Get behind the wheel of a world of elegance. In comes Sportage, a splash of style, a dash of class, and an epitome of superior performance and excellence.

Specifications may vary according to regions.



Unmatched Beauty

Pull over anywhere and grab instant attention! This is what Sportage is set to deliver. A striking design with stunning curves, accentuated with eye-catching colors, this car wins hearts everywhere it goes.

Specifications may vary according to regions.

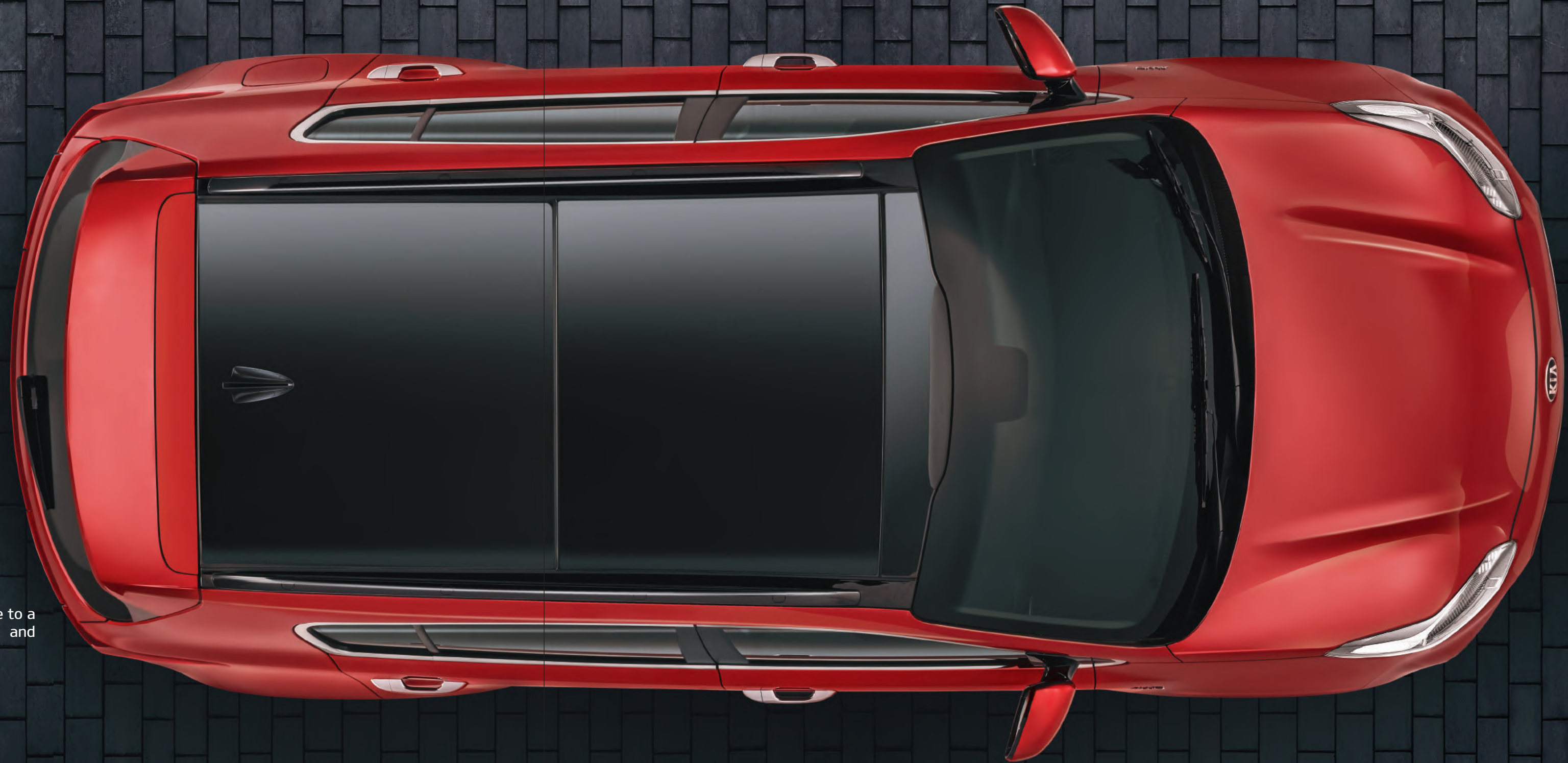

A Classy Perspective

Designed to dazzle, born to dare, Sportage takes your driving experience to a whole new level. A combination of state-of-the-art technology and outstanding attention to detail, it is time to flaunt the road in style.



Confidence Redefined

Imagine a challenging terrain, bright daylight, and a yearning for adventure. In comes Sportage, with its vibrant appeal, a distinctive appearance and over the top performance, and you have what will be the most memorable driving experience of your life.

Specifications may vary according to regions.

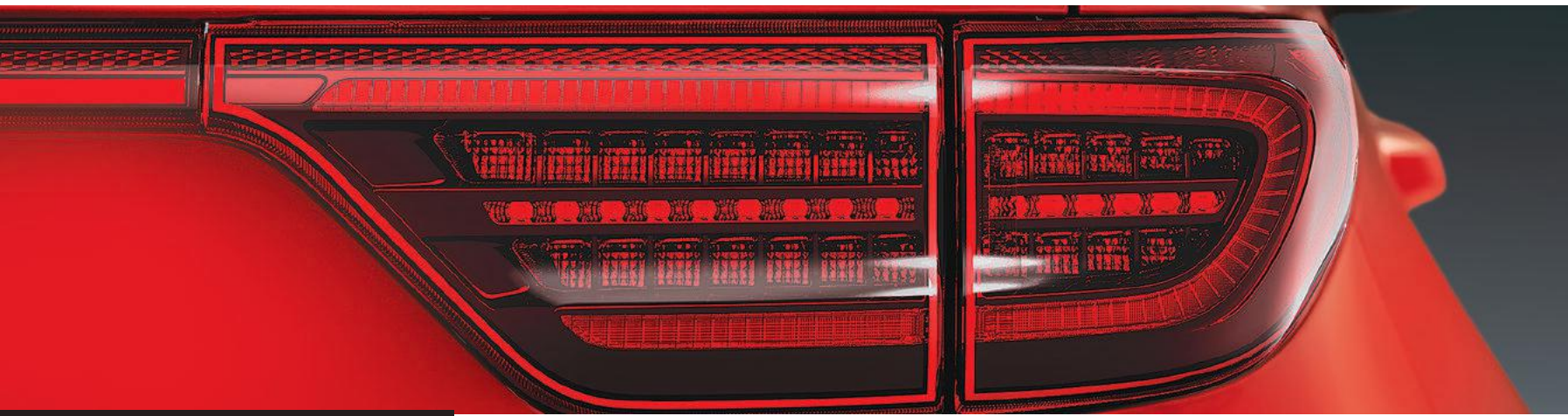
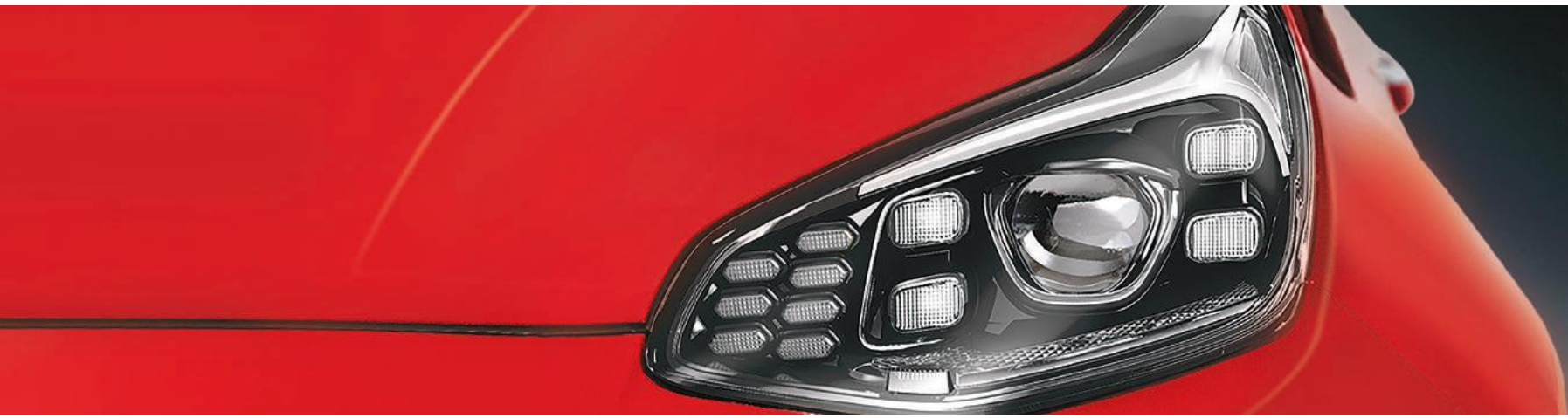

Unrivaled Aesthetics

Great aesthetics are all about turning heads wherever you go. More than that, it's about going beyond the ordinary and achieving the impossible of coming out with the most unmatched artistry one could possibly achieve. Sportage, the perfect embodiment of great style and unrivaled aesthetics.

Unparalleled Style

Go everywhere while drawing admiring glances with Sportage's eye-catching design and classical appearance. It moves with an air of sophistication around it, leaving the onlookers in awe while giving it an aura of power and dignity.



Specifications may vary according to regions.



Elegant and Classy—Inside Out

Sportage boasts a captivating interior made of the finest materials, sporting a vibrant exterior design that combines both comfort, class and pure elegance, so when your eyes are on the road, heads turn around to see this marvel on the go.

Specifications may vary according to regions.



Own Your Driving Space

Take the comfort of your room on the move with Sportage. With its meticulous placement of controls and features, your driving space offers you impeccable convenience and a greater sense of serenity every time you drive.

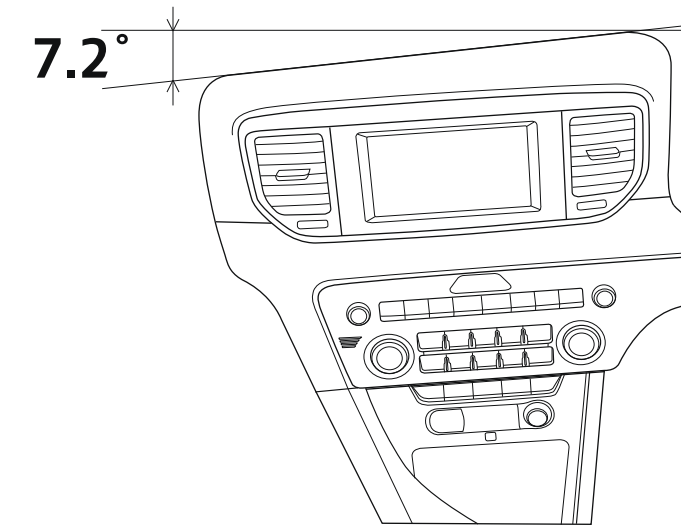

Center fascia

The center fascia is angled towards you at a perfect 7.2-degree angle so that audio and air conditioning systems are all within easy reach. The combination of well-thought-out ergonomics and logical control placement is simply unbeatable.

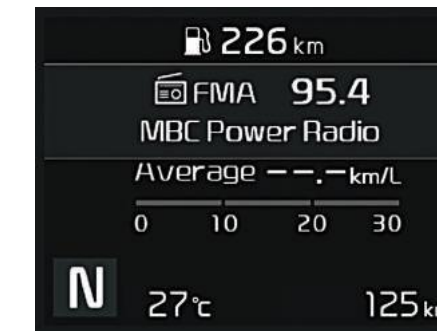

3.5-inch monochrome TFT-LCD Valuable information including total mileage, outside temperature, average speed and distance traveled is clearly displayed, enabling you to keep your eyes on the road ahead.



Adding Convenience To The Mix

Class is incomplete without comfort. From adjustable power seats that keep you cushioned comfortably throughout the journey to power lumbar support that keeps you aligned on the seat without feeling any discomfort, even the longest drives are a delight with Sportage.

Specifications may vary according to regions.



Comfort That Lasts

Now you can relax and recline in the back seat like no other. Adjust the seats according to your liking and sit back choosing your desired reclining position, thanks to its flexible and adjustable back seat recliners.

Specifications may vary according to regions.



A Journey With A View Like Never Before

A large panoramic sunroof opens to offer a scenic view of the sky and surroundings, giving you a sense of freedom when you are on the move while offering you a memorable driving experience inside the car.

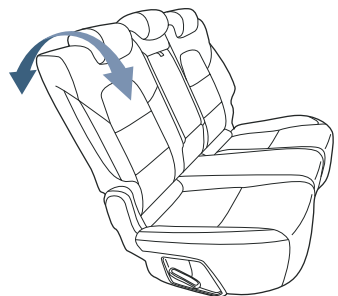

Flexible rear-seat reclining Passengers sitting in the second row of the Sportage have more opportunities to relax and recline unlike any other. Easy-to-use levers placed carefully on the side of each seat cushion make it easy for any passenger to sit back and choose his or her desired seat position.

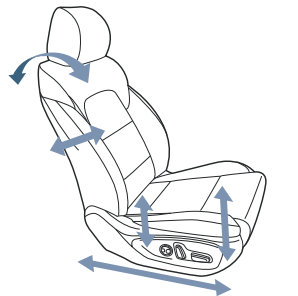

Powered front-seat adjustment The supremely comfortable 10-way adjustable driver's seat also offers 2-way power lumbar support to help keep you fresh, alert and feeling great during and after even the longest drives. The 8-way adjustable powered passenger seat ensures that whoever's keeping you company always enjoys the ride as much as you do.





Smart power tailgate
To make life even easier when your hands are full, the tailgate automatically opens when you are holding the smart key and are within the detection zone.

Tailgate memory function
Set the tailgate's opening angle for extra convenience when loading and unloading cargo.



Fully folding rear seats Rear seats fold completely flat to transport cargo more easily and safely.



60:40 split folding rear seats The foldable rear seats allow for loading extra-sized items that would not normally fit in the rear cargo space.



Dual-level luggage board Increased cargo space height enables you to load even more extra-large items.



Cargo screen storage compartment The retractable cargo screen can be conveniently stowed away in a partitioned-off space under the floorboard.

More Space For Your Growing Needs

When it comes to Sportage, there is no such thing as limited space. No need to leave your favorite belongings behind because you are in for an all-inclusive experience of a lifetime. Hop in with your cargo and hit the road!

Technological Innovation At Its Best

With Sportage, a whole new splurge of technological innovation meets increased safety and convenience. We have engineered Sportage using state-of-the-art technology to make sure you stay safe and secure on the road and reach places unscathed and in utter peace of mind.



Parking Distance Warning-Forward (PDW-F)

Ultrasonic sensors on the front and rear bumpers detect objects or pedestrians and let you know their distance from your vehicle.



Vehicle Stability Management (VSM)

This technology helps you to keep stable and safe when simultaneously braking and cornering, especially on wet, slippery or rough roads.



Cruise Control (CC)

Set and maintain a constant speed, and simply step on the brake or accelerator when you want to disengage.

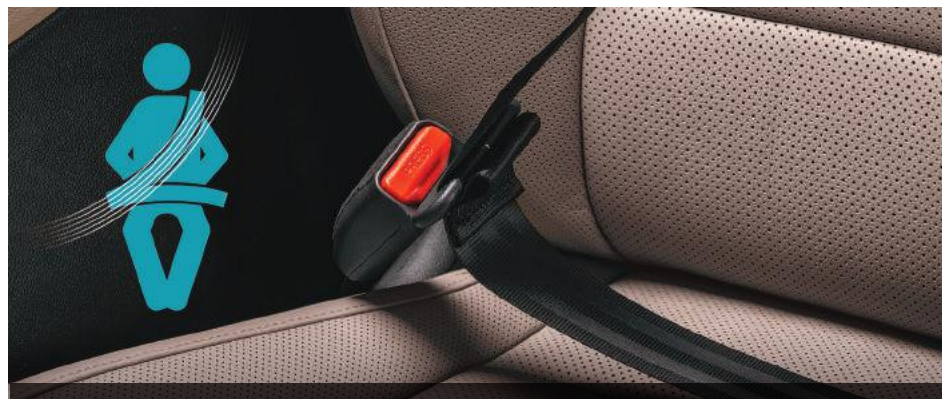

Seat Belt

Seat belt pretensions pull the front-seat passengers with full force into the seat, in case of abrupt halts or collisions, preventing them from colliding against the dashboard and positioning them to receive maximum air bag protection.



Airbags placed strategically offer protection for you and your passengers in the event of a collision.



Child Anchor Keep your child safely and securely seated by strapping their seat to the vehicle using straps from the child safety seat that connect to special metal anchors in the vehicle.



Hill-Start Assist Control (HAC) We know what it is like when you have to pull away from a standing start while you drive on a steep upward incline. HAC stops you from rolling backwards.



Downhill Brake Control (DBC) Sportage's DBC supports the driver driving down a steep hill without the driver depressing the brake pedal. It slows down the vehicle and lets the driver concentrate on steering the vehicle.



Anti-lock Braking System (ABS) Sportage's ABS operates by preventing the wheels from locking up during braking, thereby maintaining tractive contact with the road surface.

Performances That Breaks Boundaries

Open your garage for this unfettered beast. Sportage features a fluid automatic transmission that makes it bullet through with greater efficiency, allowing greater control of the car while offering you a peaceful driving experience.



Nu 2.0 MPI gasoline engine

Max. power
157 ps @ 6,200 rpm (EURO 2)
Max. torque
20 kg·m @ 4,000 rpm (EURO 2)



Automatic transmission

This six-gear unit features auto shift lock to prevent any unintended acceleration from happening.



Drive Mode Select (DMS)

Standard on all Sportage automatic transmission models, DMS enables you to select Normal, Eco or Sport mode to suit the way you wish to drive depending on the road and weather conditions.

Performance That Grips Attention

Sportage's superior road performance is strongly attributed to its well-reinforced chassis design that ensures exemplary control, unparalleled performance, and phenomenal protection. With Sportage's optimum road grip, coursing through even the most challenging terrains becomes a dream come true.

Phenomenal rigidity with smarter materials

The Sportage boasts substantial torsional rigidity thanks to strategic application of remarkably strong materials such as hot-stamped steel. The body resists twisting forces, so jolts are absorbed with precision. In the event of a collision, impact forces are managed in ways that better protect the occupant space.

Advanced adhesives

We've applied a best-in-class 103 meters of structural adhesive to enhance vehicle body strength while minimizing noise and vibration for a smoother ride.



DYNAMAX AWD

True AWD. Continuously thinking forward.

The automatically engaging all-wheel drive (AWD) system senses road conditions, wheel speed and acceleration, then applies the right amount of torque to the front and rear wheels for optimum road grip. Rest assured knowing that you can always tackle any kind of road or weather condition.



Suspension The design and geometry of the Sportage's improved suspension offers even more stable handling at high speeds for your safety and enhanced driving comfort.

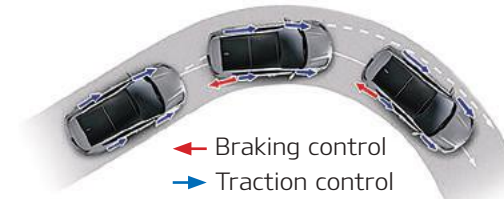

Advanced Traction Cornering Control (ATCC)

Advanced Traction Cornering Control monitors and analyzes road conditions, making sure the right amount of torque is focused on the wheel with the most grip to counteract over or understeer.

Everything You Desire

It's not just a car, it's a lifestyle. With a well-thought-out range of high quality interior features and an exterior design that commands attention and admiration, everything is placed within your easy reach, so you could just slip behind the wheel, sit back, and drive on.



8-inch infotainment system This simple-to-use, 8-inch infotainment system, navigation and control systems, and incorporates the rearview camera display with dynamic guidelines.



USB port You and your passengers can connect USB or other mobile devices for convenient music playback.

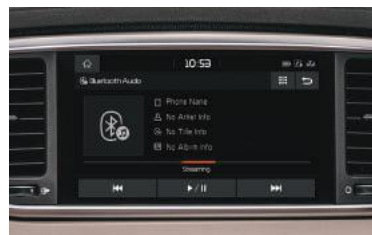

Bluetooth Steering-wheel mounted controls enable you to effortlessly stay connected while on the move.



Audio remote control Fingertip control of the sound system means you will never be distracted from the road ahead.



Auto Light Control The headlamps are engineered to respond smartly to external light and adjust to its levels for better driving facilitation in the night time.



Day Time Running Lamp These LED lights keep running whenever the engine is on and increase the visibility of your cars for other vehicles on the road.



Fog Lamp Greater visibility can be achieved without compromising on the appealing design aesthetic, thanks to the fog lamps that keep clear and well lit throughout the journey.



High Mounted Stop Lamp Other vehicles need to vividly see you stopping on the road, thanks to the high mounted LED stop lamp integrated in the rear spoiler.



Leather Seat Covering Durability and comfort go hand in hand. Sportage features leather-covered seats of premium quality that offers great comfort while withstanding the daily wear and tear.



Auto defogger A sophisticated sensor detects fogging on the front windshield and clears it automatically, giving you driving clarity at all times.

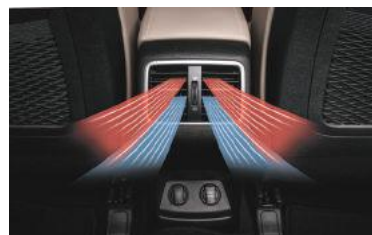

Ventilation and USB charger for 2nd row passengers Cold or warm air is available when needed and your rear seat passengers can also recharge their devices on the go.



Air purifier A smart ion generator is ever-ready to remove the sources of unpleasant smells, clearing the interior air for an enjoyable ride.

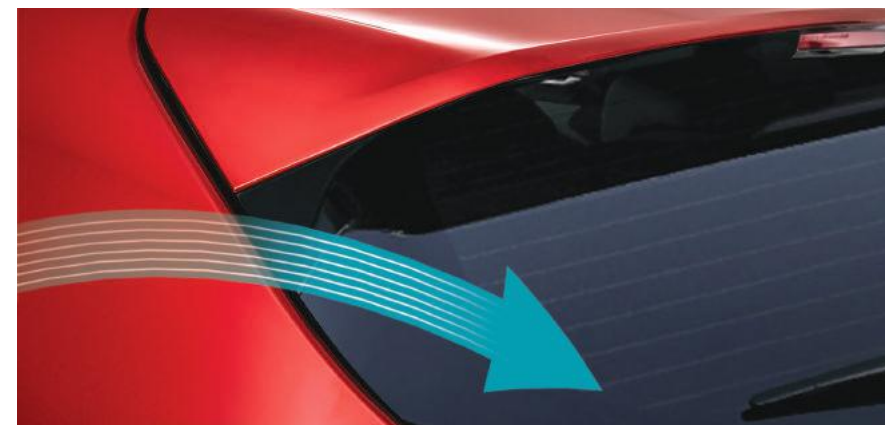

Aerodynamic improvements The smart rear-spoiler side garnish minimizes the drag coefficient for improved fuel efficiency while a state-of-the-art wheel air curtain improves the flow of air around the front wheels to offer you a more comfortable driving experience.



Smart welcome system Approach your vehicle with the smart key fob and the Sportage springs into life once you're comfortably within range. Welcome lights turn on and the outside mirrors unfold into position so that you're ready to be on the move again.



Electronic Parking Brake (EPB) State-of-the-art switch design for activating the parking brake provides added convenience and saves space.



Parking guide system Steering wheel mounted angle sensors and a rear-view camera indicate the projected trajectory of your vehicle for added safety.



Roof rack The integrated roof rack is designed for maximum luggage storage while additional accessory crossbars offer you extra utility.



Dual Zone Full Auto Temperature Control (D-FATC) Set-and-forget functionality turns the air conditioner and heater on and off automatically to maintain the perfect temperature for you and your passengers at all times.



Button start / stop For convenience and safety, you don't have to take the key fob out of your pocket when you're locking or unlocking the door, starting the engine or disengaging the immobilizer.

Specification Sheet

Features	Alpha	Front Wheel Drive	All Wheel Drive
Dimensions			
Length (mm)		4485	
Width (mm)		1855	
Height (mm)		1635	
Wheel Base (mm)		2670	
Minimum Ground Clearance (mm)		172	
Fuel Tank (Litres)		62	
Wheel Tread Front (mm)		1613	
Wheel Tread Back (mm)		1625	
Performance			
Engine Type	Nu 2.0L Gasoline MPI		
Displacement (cc)	1999		
Drivetrain	Front Wheel Drive		All Wheel Drive
Maximum Output (kW(ps)/rpm)	115(157)/6200		
Maximum Torque (Nm/rpm)	196/4000		
Transmission	6 Speed Automatic Transmission + SportMatic		
Fuel Supply System	Multi Point Injection		
Bore x Stroke (mm)	81 x 97		
Compression Ratio	10.3		
Front Suspension	McPherson Strut		
Rear Suspension	Multi-link		
Brake (Front)	16" Disc		
Brake (Rear)	16" Disc		
Drive Mode	Normal + Eco + Sport		
Tyre	225/60R17	225/55R18	
Wheel Type	17 Inch Alloy Rims	18 Inch Alloy Rims	
Spare Wheel	Alloy	Steel Rim	Alloy
Safety			
Airbags	Driver + Passenger		
Electronic Stability Control	x		•
Downhill Brake Control	x		•
Hill-Start Assist Control	x		•
Vehicle Stability Management	x		•
ISO Fix Child Anchor		•	
Anti-Lock Braking System		•	
Exterior			
Panoramic Sunroof	x		•
Roof Rack	x		•
Headlamps	Bi-Function Projection Halogen	Bi-Function Projection LED	
Position Lamps		LED	
Daytime Running Lamps		LED	
Side Repeater Lamp		Outside Mirror	
Rear Combination Lamps	Bulb		LED

Features	Alpha	Front Wheel Drive	All Wheel Drive
Outside Mirror	Electrically Adjustable + Retractable + Heated		
Fog Lamps (Front + Rear)	Bulb		
Auto Light Control	•		
High Mounted Stop Lamp	LED		
Antenna	Shark Fin Type		
Outside Handles	Half Chrome Coating		
Interior			
Steering Wheel Material	Leather Wrapped		
Steering Column	Tilt and Telescopic		
Steering Switches	Audio, Call, Voice Recognition, Cruise Control, MID		
TFT Cluster	3.5" Cluster Conventional TFT LCD + Rheostat		
Gear Shift Knob Material	Leather Wrapped		
Inside Rear View Mirror	Electrochromic Mirror		
Multimedia System	7" Infotainment with Android Auto and Apple CarPlay with Bluetooth	8" Infotainment with Android Auto, Apple CarPlay with Bluetooth, Playable Videos and Weblink	
Power Windows	Power (Driver Auto Up/Down)	Power (Driver Auto Up/Down and Safety)	
Speakers	6		
AUX / USB Connectivity	Aux (Front) + USB (Front + Rear)		
Air Conditioner	Automatic Dual Zone Climate Control		
Seat Reclining (Front)	Manual	2-Way Powered (Driver+Passenger)	
Seat Sliding (Front)	Manual	2-Way Powered (Driver+Passenger)	
Height Adjuster (Front)	Pumping Type		2-Way Powered (Driver+Passenger)
Cushion Tilting (Front)	-		
Adjustable Lumbar Support (Front)	Manual	2-Way Powered (Driver)	
Seat Material	High Grade Farbic	Premium Fabric	Premium Leather
60:40 Split with Recliner (Rear)	•		
Room Lamps	Bulb		LED
Personal Lamps (Rear)	Bulb		LED
Overhead Console Lamp	Bulb		LED
Vanity Mirror	Illuminated		
Cigar Lighter	•		
Ashtray	•		
Cup + Bottle Holders	6		
Comfort and Convenience			
Door Lock System	Smart Key with Push Start		
Park Assist Sensors	x	Reverse with Switch	Reverse + Forward with Switch
Cruise Control	•		
Rear View Camera	•		
Air Purifier	•		
Window Defogger	Automatic		
Seat Belts	5		
Electronic Parking Brake	Manual	Electric Parking Brake	
Auto Hold	x		•
Central Door Lock	•		
Tailgate	Manual		Power + Height Adjustable + Memory Function
Immobiliser	•		
Rain Sensor	•		

The Power to Surprise

Kia is the newest and most exciting force of change in the automotive world and we are ready to change the way you feel and think about driving. More than just a promise, we are committed to making driving a true pleasure for customers across the globe. With youthful and dynamic styling and the latest in advanced technologies, Kia cars are turning heads the world over with the power to surprise. From the Picanto to the Mohave, Kia offers a full lineup of sedans, SUVs and MPVs that are not only practical and stylish but downright exhilarating to drive. Keep your eyes on Kia because our best has yet to come.

About Kia Motors Corporation

Kia Motors Corporation (www.kia.com) – a maker of quality vehicles for the young-at-heart – was founded in 1944 and is Korea's oldest manufacturer of motor vehicles. It produces over 3 million vehicles annually through 10 manufacturing and assembly operations located in 5 countries. These are then sold and serviced through a network of distributors and dealers spanning around 180 countries. Kia currently employs around 50,000 people worldwide and has annual revenues exceeding US\$44 billion. It is the major sponsor of the Australian Open and serves FIFA, the governing body of the FIFA World Cup™ as official automotive partner. Kia Motors Corporation's brand slogan – "The Power to Surprise" – represents the company's global commitment to surprise the world by providing exciting and inspiring experiences that go beyond expectations.



/KiaMotorsPakistan



/KiaMotorsPk



/kiamotorspakistan



/KiaMotorsPakistan



/Kia-buzz.com



KIA LUCKY MOTORS PAKISTAN LIMITED

8TH FLOOR, AL-TIJARAH CENTER, 32-1A, BLOCK 6, PECHS, SHAHRAH-E-FAISAL, KARACHI.

Phone # 111-111-KIA (111-111-542)

www.kia.com/pk



australian open



MAJOR SPONSOR



FRANCE 2019



Official Partner



EUROPA LEAGUE



Official Partner